

980889

1.

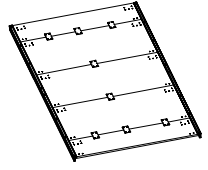

2.

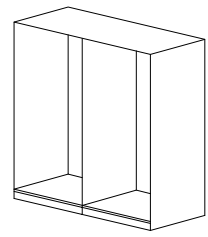
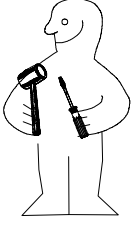

1.

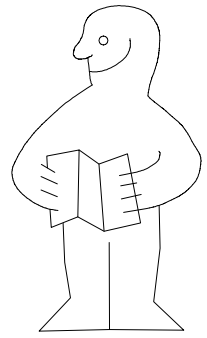
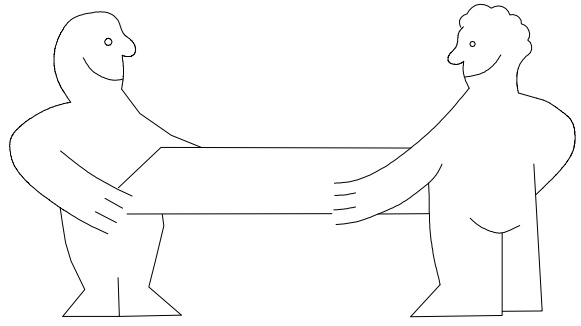
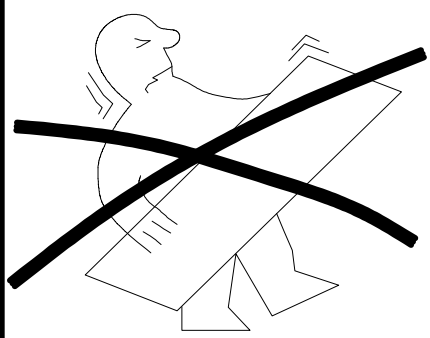
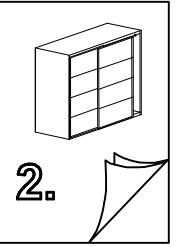
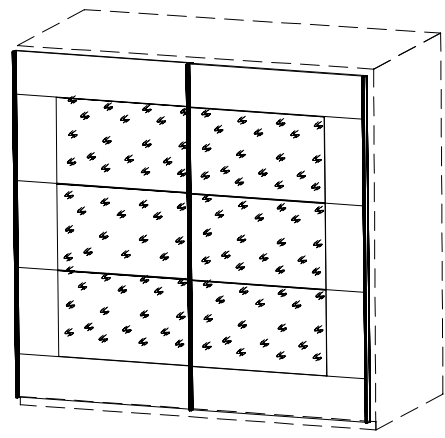

1-2-3-4... ○

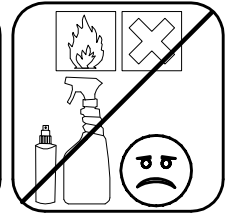
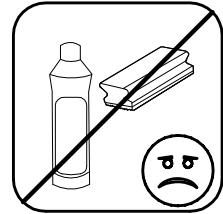
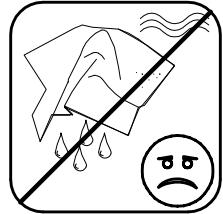
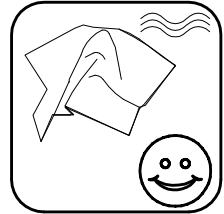
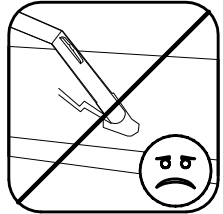
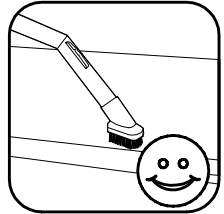
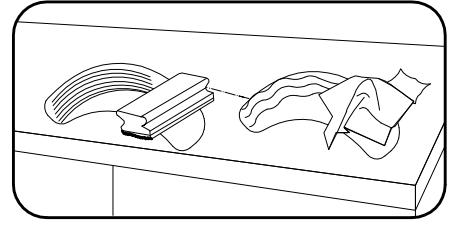
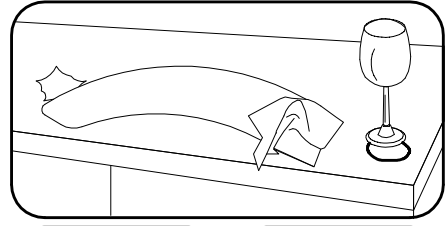
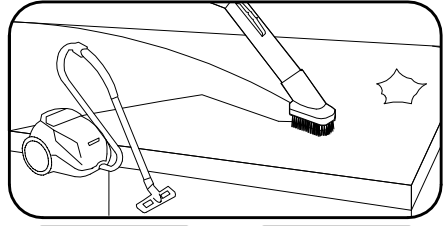
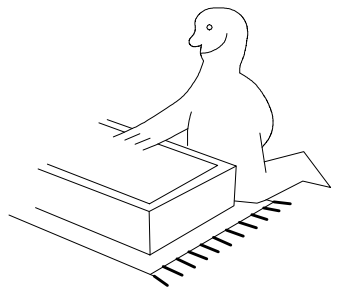
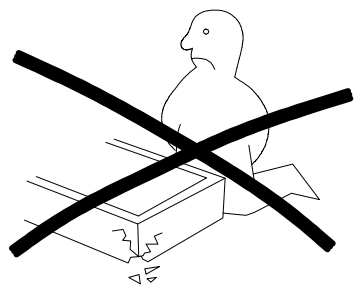
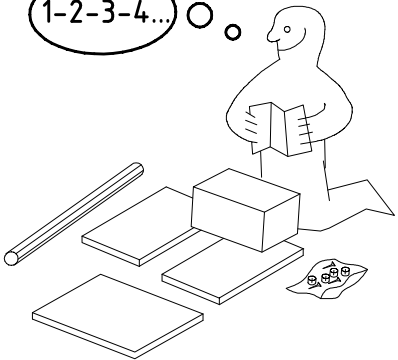

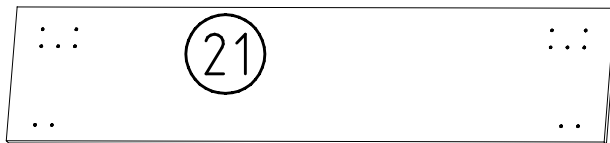
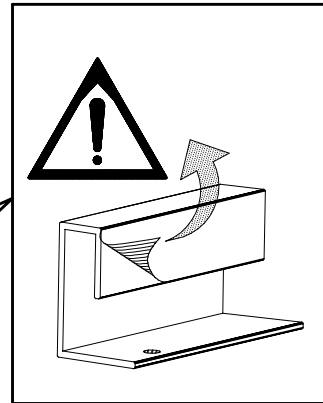
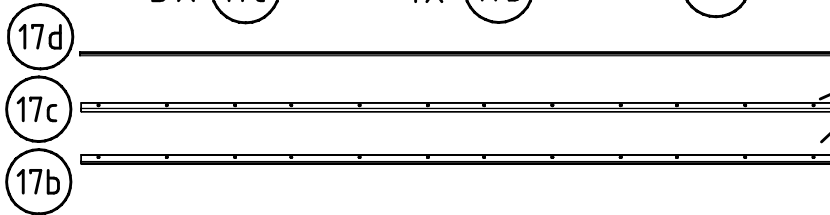
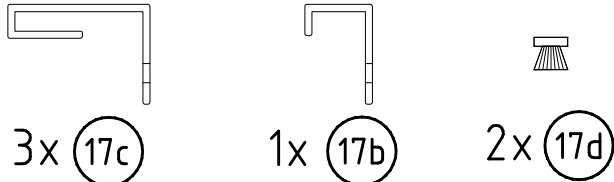
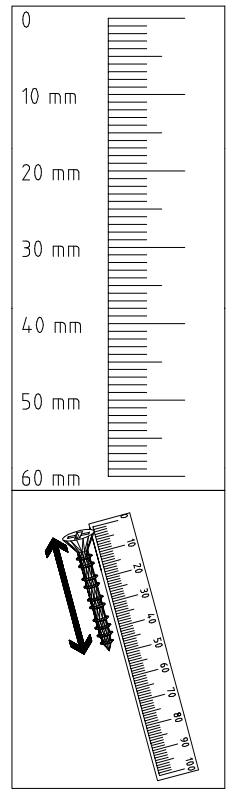
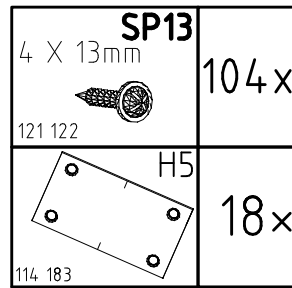
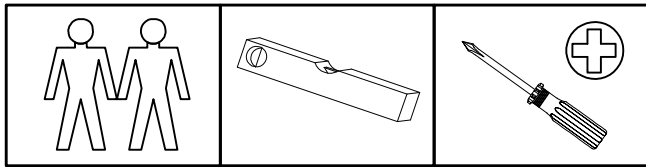

4x 695 / 916 / 1135 / 1357 / 1579 x 252 x 15

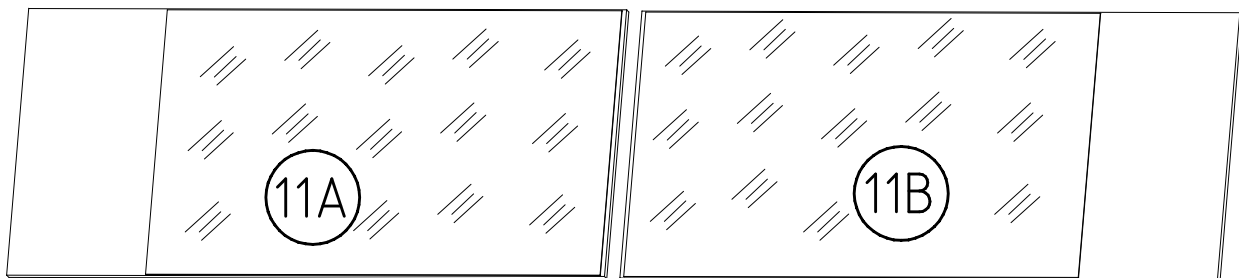

6x 695 / 916 / 1135 / 1357 / 1579 x 504 x 15 3x A / 3x B

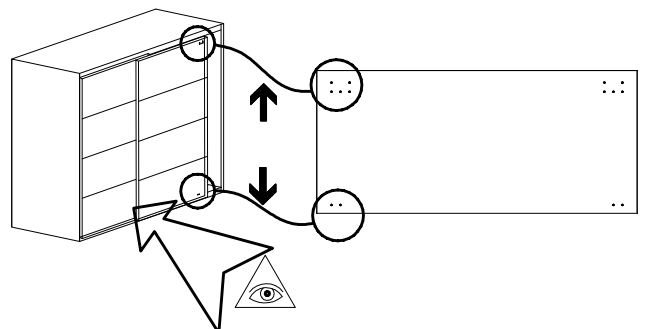
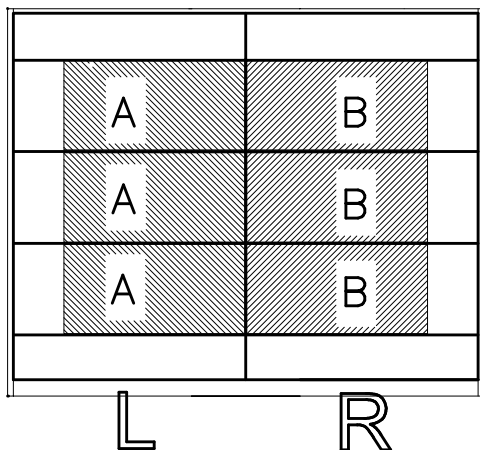

1

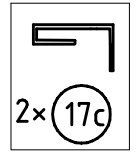
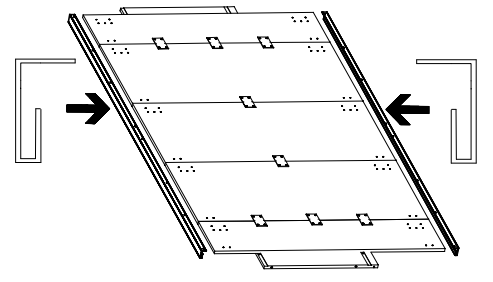
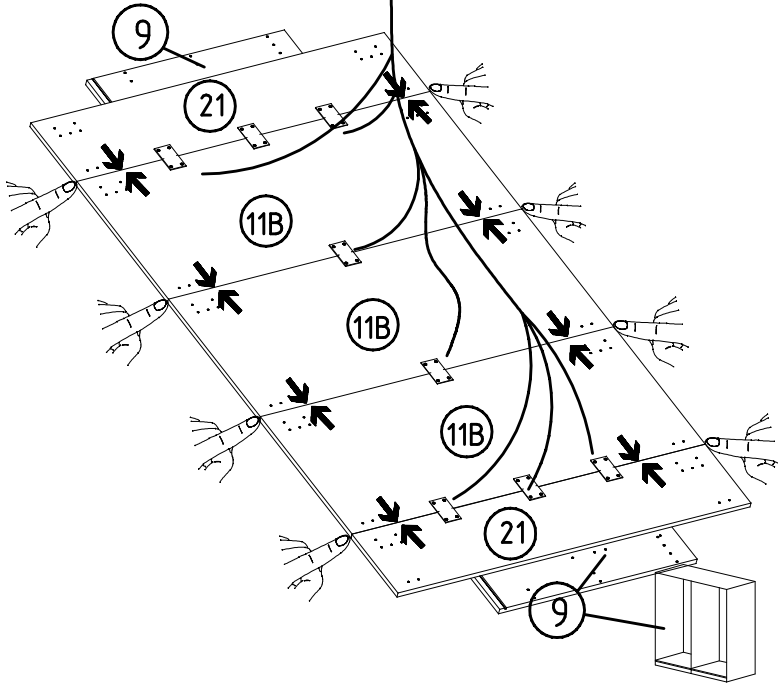
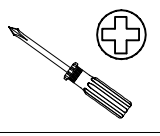
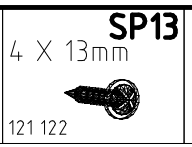
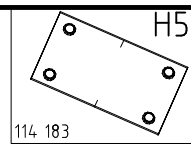
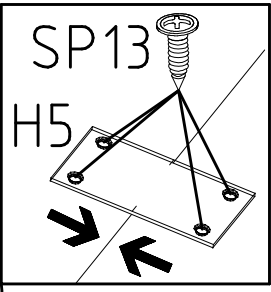
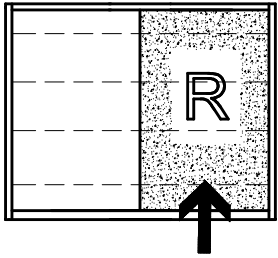

2

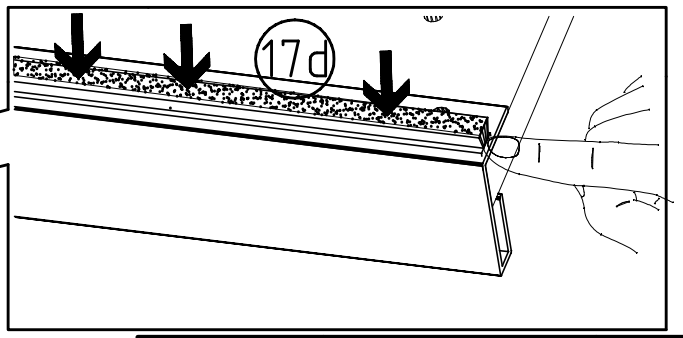
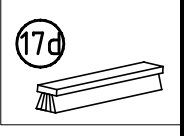
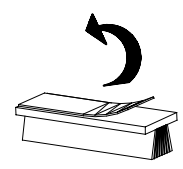
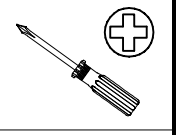
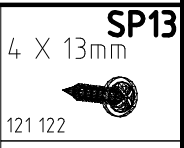
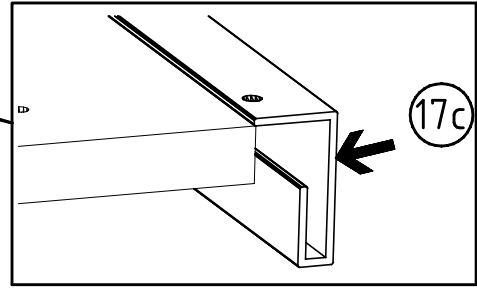
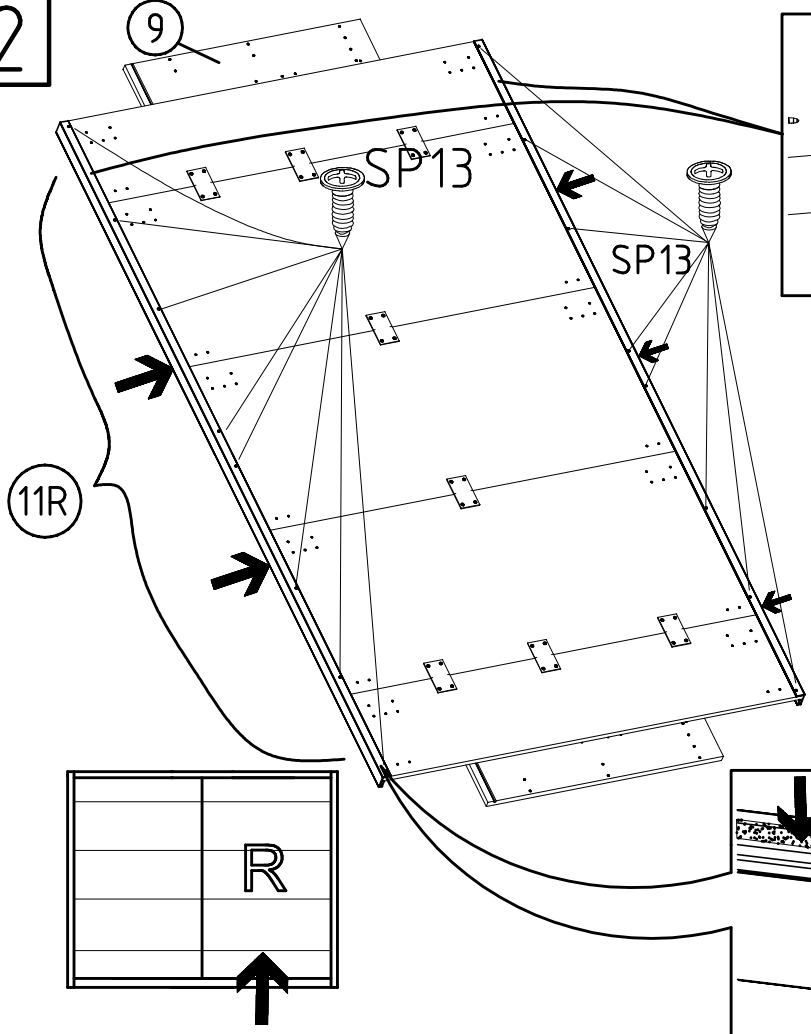

3

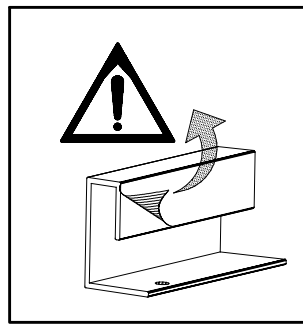
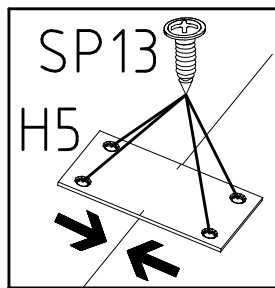
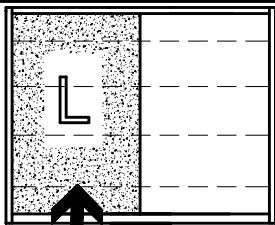

H5 4 X 13mm
114 183 121 122

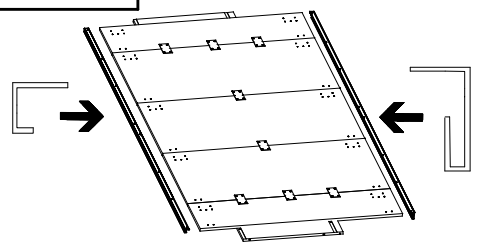
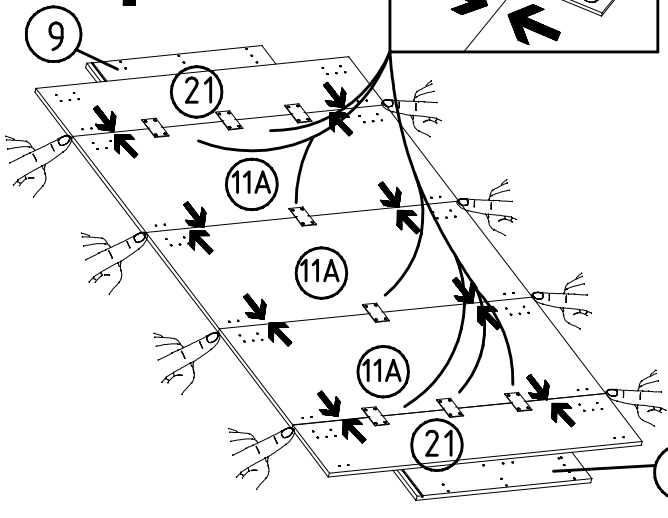

1x (17c) 1x (17b)

4

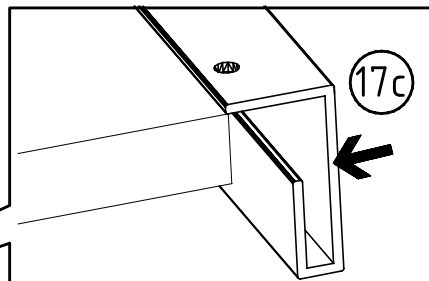
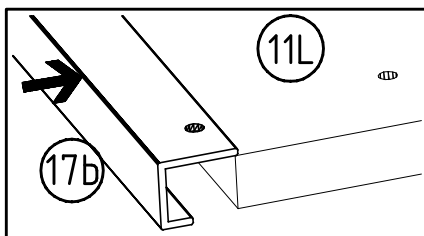

SP13 4 X 13mm
121 122

